

SUSPENSIONS

Introduction to **Type 08**

Single Cable Drop Suspended H-Rail

- Aesthetically pleasing installation
- Stable installation
- Great for larger diameters with retention system
- RapidSlider is used to fix the duct to the H-Rail

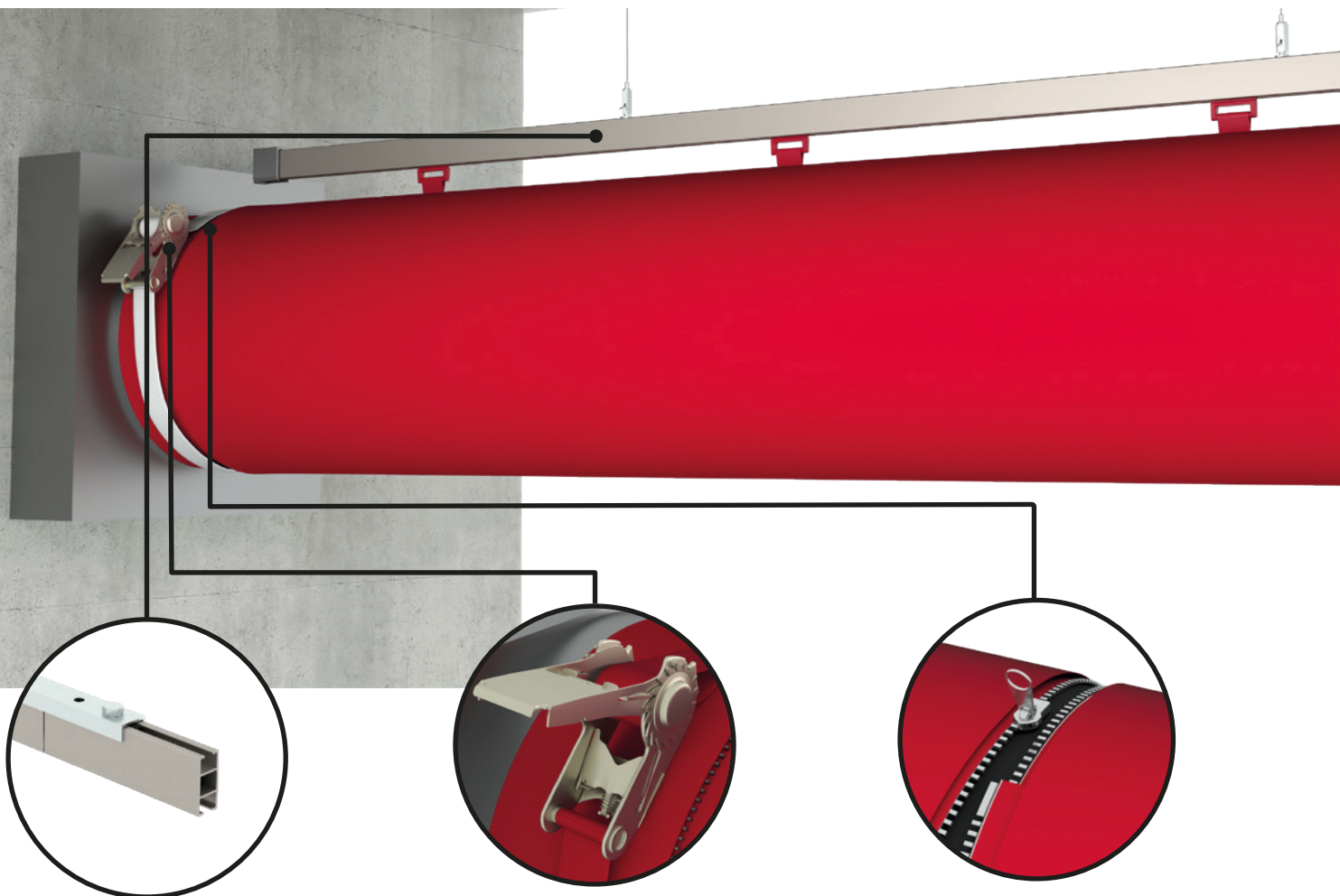

Ducts are suspended with Adjustable Cable Drop. The H-rail, so named because it looks like a H in the cross section, is made out of anodized aluminum, making it an excellent choice for corrosive environments.

Example of duct system configuration

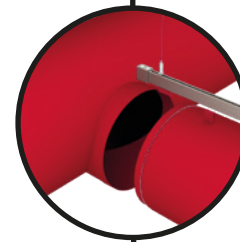
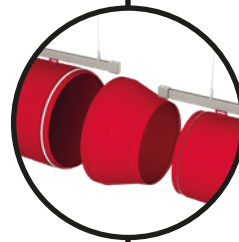
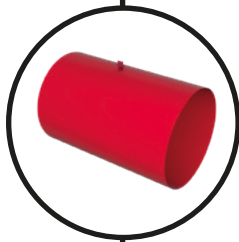
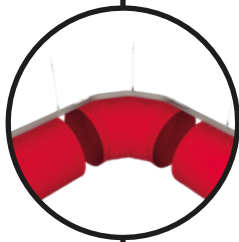
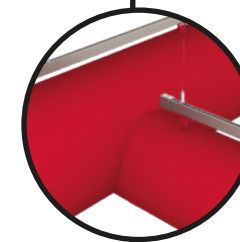
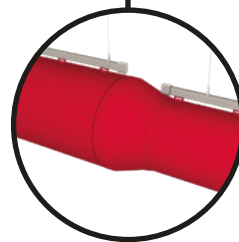
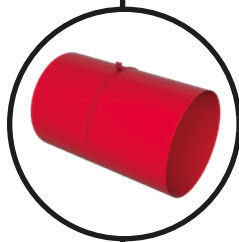
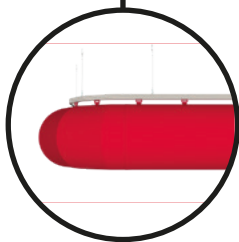
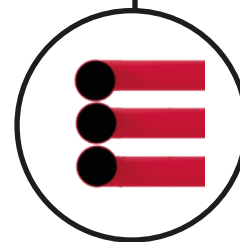
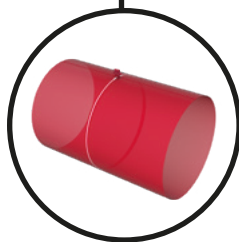
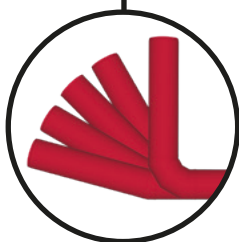
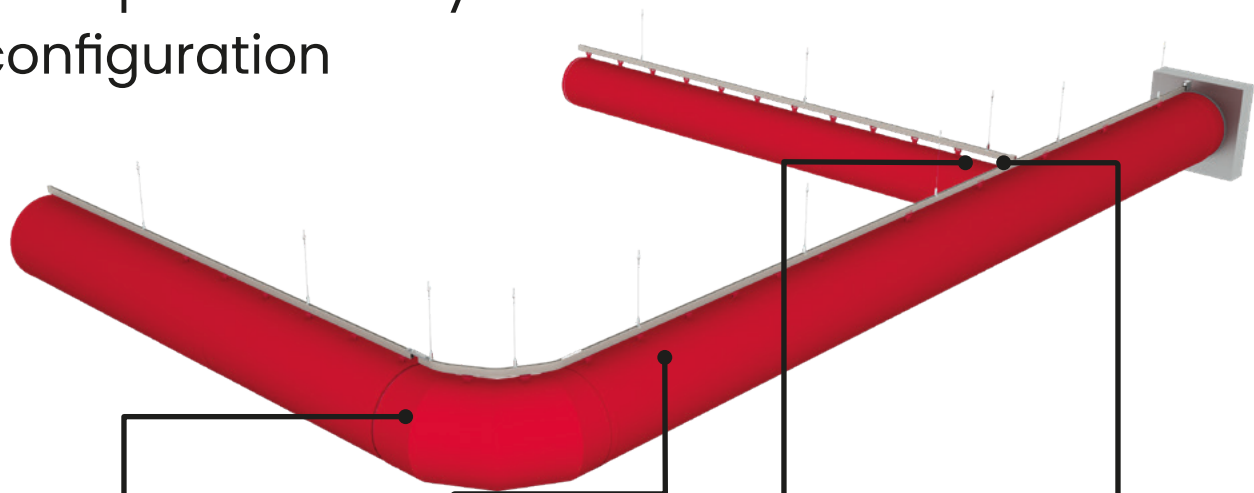

Elbows

We provide custom elbows in any degree and size.

Shape Retention

Our ducts come with your selected Shape Retention solution: All-in-One or Internal 360° Hoops. The 360° hoops are hidden inside the duct whereas All-in-One 180° hoops are sewn on the exterior. Shape retaining hardware is removable for laundering.

Reductions

Concentric and eccentric reducers are available.

Branches

Concentric and eccentric branch take-offs are available.

H-RAIL for Type 08

When assembling an H-rail system the pieces of H-rail are joined together by using a metal connector that is fastened to each rail using set screws. The duct will have RapidSlider with a special feeder to slide into the H-rail at the appropriate locations for both single and double H-rail configurations. The rails are bent to the exact angle that is needed to suit the elbows in your Zip-a-Duct system.

